



TAI-SAW TECHNOLOGY CO., LTD.

No. 3, Industrial 2nd Rd., Ping-Chen Industrial District,
Taoyuan, 324, Taiwan, R.O.C.

TEL: 886-3-4690038 FAX: 886-3-4697532

E-mail: tstsales@mail.taisaw.com Web: www.taisaw.com

Product Specifications Approval Sheet

Product Description: Low-Loss 70MHz IF SAW Filter (BW=4 MHz)

TST Part No.: TB0211A

Customer Part No.: _____

Customer signature required
Company: _____
Division: _____
Approved by : _____
Date: _____

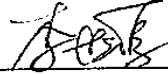
Checked by: _____ Kazuma Lee 

Approved by: _____ Francis Chen 

Date: _____ 2010, 03/16

1. Customer signed back is required before TST can proceed with sample build and receive orders.
2. Orders received without customer signed back will be regarded as agreement on the specifications.
3. Any specifications changes must be approved upon by both parties and a new revision of specifications shall be released to reflect the changes.



TAI-SAW TECHNOLOGY CO., LTD.

No.3, Industrial 2nd Rd., Ping-Chen Industrial District, Taoyuan, Taiwan, R.O.C.

TEL: 886-3-4690038 FAX: 886-3-4697532

E-mail: tstsales3@mail.taisaw.com Web: www.taisaw.com

Low-Loss 70 MHz IF SAW Filter (SMD 13.3×6.5 mm)

Model No.: TB0211A

Rev. No.:4

A. Maximum Rating:

RoHS Compliant
Lead free
Lead-free soldering

1. Input Power Level: +20 dB_m
2. Storage Temperature: -40°C to +85°C

B. Electrical Characteristics:

Reference Temperature Ta = 25°C

Parameters	Unit	Min.	Typical	Max.
Center frequency, Fc	MHz	69.8	70	70.2
Insertion Loss, IL	dB	-	8.0	9.5
1 dB Bandwidth	MHz	3.4	3.6	-
3 dB Bandwidth	MHz	4.0	4.45	-
40 dB Bandwidth	MHz	-	7.18	8.0
Relative Attenuation:				
10 to 64.5 MHz	dB	40	45	-
74 to 140 MHz	dB	40	43	-
Amplitude ripple within Fc ± 1.5 MHz	dB	-	0.9	1.0
Group Delay ripple within Fc ± 1.5 MHz	nsec	-	190	220
Substrate Material	-	-	YZ-LN	-
Temperature Coefficient of frequency	ppm/ °C	-	-94	-

C. Frequency Characteristics:

(1) Frequency Response

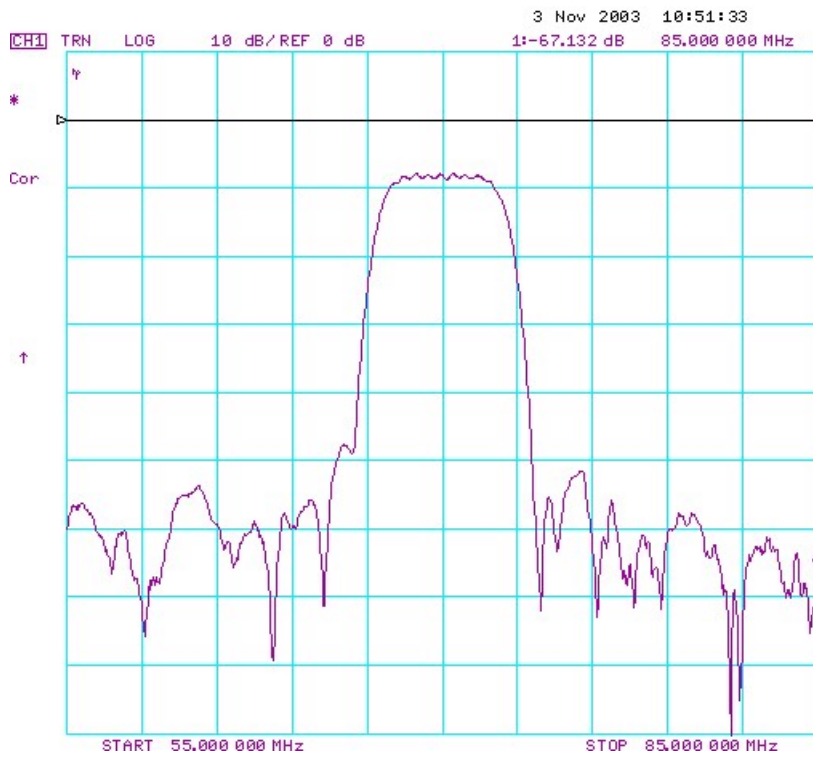

(2) Passband response and Group Delay Variation

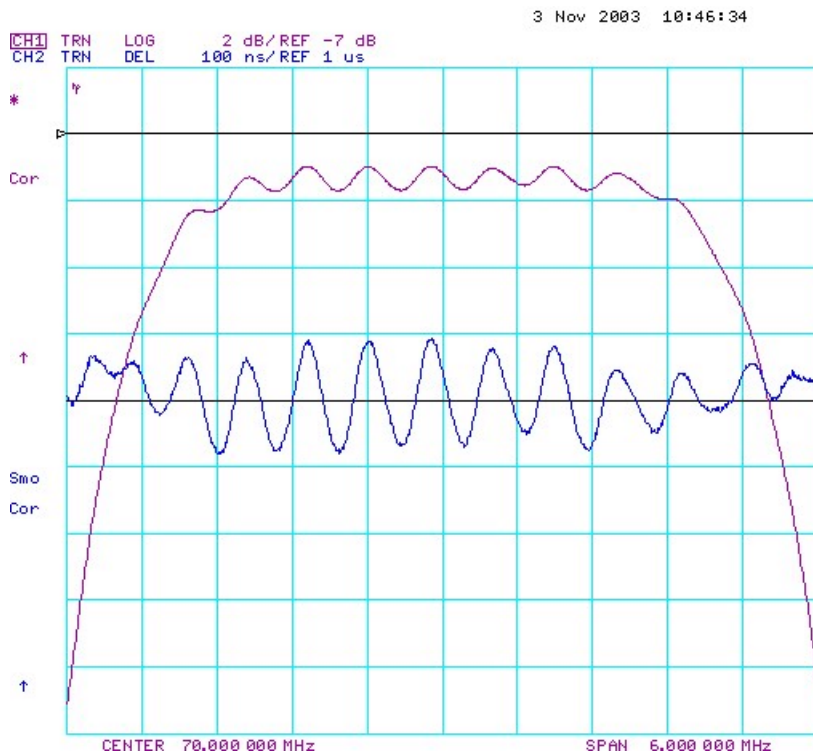

D. Measurement Circuit:

Source and load impedance: 50 Ω

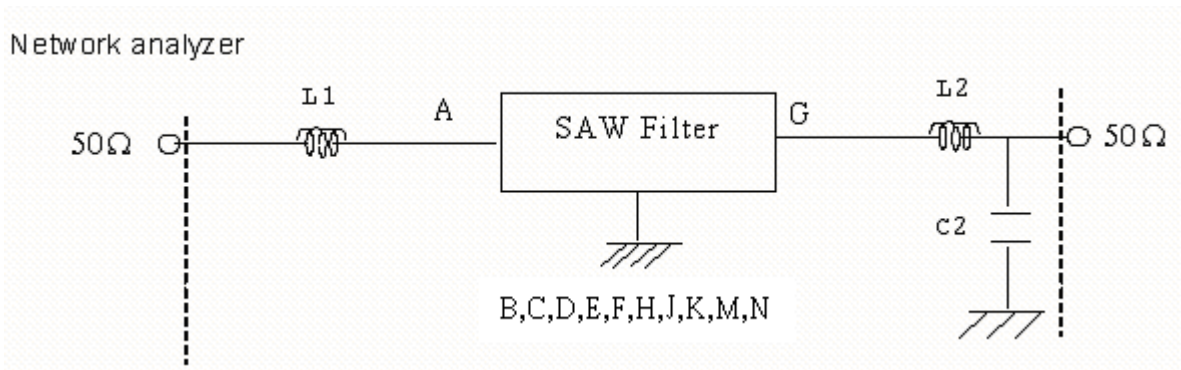

Input: L1=220 nH, Q>40
 Output: L2=100 nH, Q>40; C2=22 pF

E. Outline Drawing:

Laser Marking

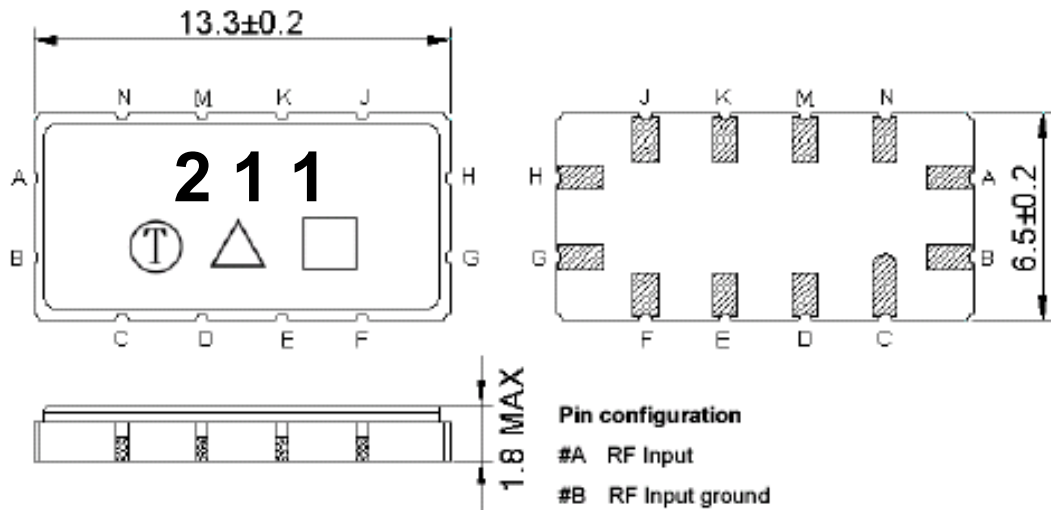

Pin configuration

- #A RF Input
- #B RF Input ground
- #G RF Output
- #H RF Output ground
- #C,D,E,F,J,K,M,N To be ground
- : Week Code (Follow the table from planner each year)
- Unit : mm
- △ : Product / Year Code

Year	2005 2009	2006 2010	2007 2011	2008 2012
Product Code	B	b	<u>B</u>	<u>b</u>

F. Packing:

1. Reel Dimension

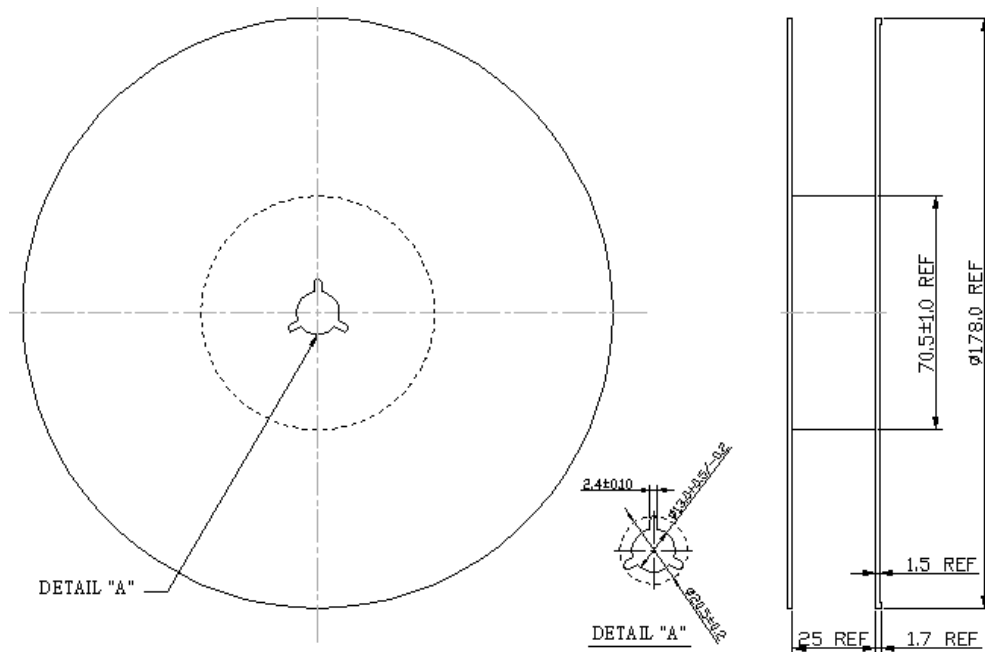

2. Tape Dimension

